

SOPHY – TOOL FOR STRUCTURAL SYNTHESIS OF CONCEPTUAL TECHNICAL SYSTEMS

J. Rihtaršič, R. Žavbi and J. Duhovnik

Keywords: structural synthesis, physical law, technical system, design knowledge

1. Introduction

The paper describes a method and a tool to support concept generation and its structural synthesis. The method includes automated generation of conceptual technical systems (TS) and their semi-automated structural synthesis. In the structural synthesis phase, the emphasis of the research is on structural visualization of automatically generated conceptual TS. The method defines relations between different parts of the structure which need to be maintained also during final structural modifications made by design engineer. Intervention of design engineer in structural synthesis phase allows his/her creative contribution to the final structural design. For description of so generated technical system's properties we use physical laws while the relations between parts of structure that contribute to realisation of the function are defined by basic schemata. The method was implemented into the computer tool SOPHY (Synthesis **O**f **P**HYSical laws). The application is not limited to a particular engineering domain.

2. Background and related work

Computer tools have a significant impact on efficiency in the product development process which is reflected in quality as well as in shorter development time [Mortensen 1999]. Rationalization of the development process in industry is mainly achieved with automation and standardization of development methods. But it is not sufficient for such methods and tools only to enable repeatability of the results; they also have to support the growth of knowledge about the evolved TS [Bender 2004]. They should increase the insight into the TS and guide the designer from requirements to feasible products [Ullman 2002]. Insight and the feasibility of a product are strongly correlated with elements used for generation and evaluation of new conceptual TS. However, it is not enough for a conceptual design tool to support only idea generation; it should also provide support for idea development and its embodiment. A design engineer must be aware of how structure affects the functionality of the TS and, vice versa, how functionality influences the structure of an artefact.

For fulfilment of the above-mentioned requirements, selection of physical laws seems a reasonable choice as starting point for concept generation. Physical laws, their effects and working principles represent the basis for concept generation in several manual and automated tools to support the conceptual design phase [Koller and Kastrup 1994, Chakrabarti 2004, Žavbi and Duhovnik 2000]. Physical laws and their combinations enable effects needed for realization of functions. Furthermore the connection between physical laws and the structure of TS enables a design engineer to understand its behaviour and optimize its structure. However, this later step from abstract functional or physical solution towards structural embodiment is often described vaguely or not at all.

In this paper, we will describe a method that supports idea generation and its structural synthesis. The focus will be on interdisciplinarity of the domains and the embodiment of abstract solutions. Although the formalism of the method guides the design engineer through all phases of a conceptual design process, it allows freedom that facilitates the search for solutions in different technical domains. The method has been implemented in a computer tool, which is used to present an example of concept generation and embodiment.

3. Physical nature of technical systems

All technical systems (TS) operate on basis of physical laws. Working principle is the result of combination between physical effect and the structure of the TS. Zavbi and Duhovnik [Zavbi and Duhovnik, 2000] proposed a method for automated chaining of physical laws. Result of the method are linear chains of physical laws with a desired output effect. However, as can be seen from Figure 1 only the “simplest” TS operate on the basis of linear chain of physical laws, such as cloth peg from Figure 1.

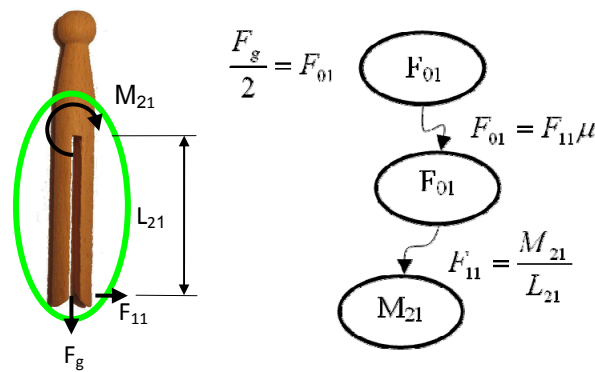

Figure 1. The chain of physical laws of a wooden cloth peg made from one part.

Most often realization of partial functions is needed for complete functionality of a TS. So additional chains of physical laws are generated and they together form a system of chains of physical laws that enable realization of desired function. Figure 2 represents cloth peg where system of chains of physical laws contribute to realization of the same function as in case of the cloth peg from Figure 1.

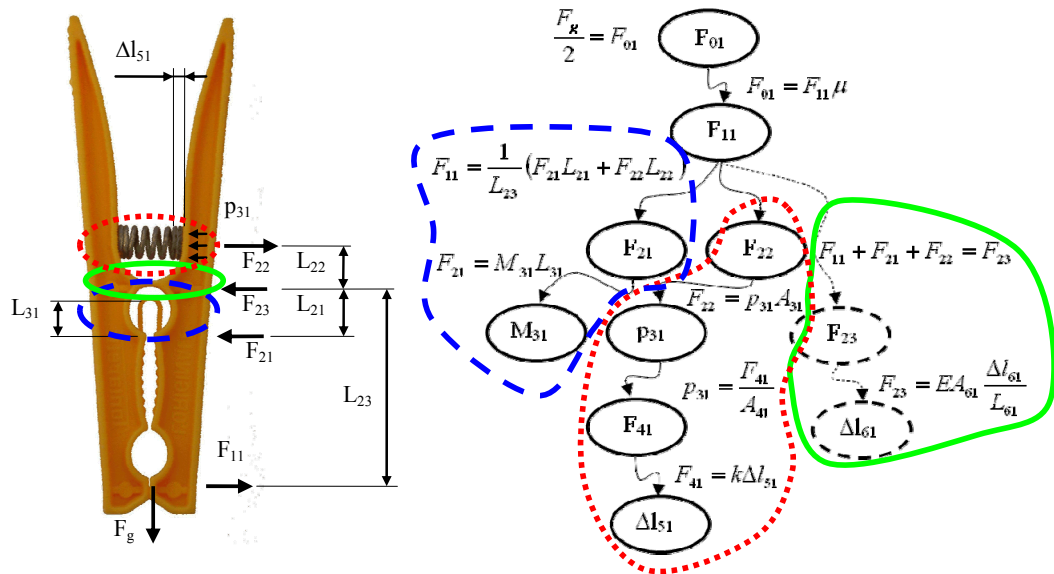

Figure 2. Chains of physical laws of plastic cloth peg made out of two parts

Nevertheless the level of functionality differs between both TS. Moreover in case of cloth peg from Figure 2, the functionality is fulfilled by two parallel structures. Physical laws and structure surrounded by dashed line works on principle of a bending spring, physical laws and structure surrounded by dotted line works on principle of a torsion spring. Both halves of the cloth peg are connected with each other over the structure surrounded by green line.

Singular chains are sufficient to describe only very “simple” TS. To enable generation of more complicated TS the connections between individual chains have to be made. This was made possible by introduction of basic schemata. Basic schemata structure for TS from Figure 1 and Figure 2 are shown in [Rihtaršič et al. 2007].

4. Basic schemata model

Basic schema is complementary to the physical law and represents physical quantities and their relations which are needed for realisation of the physical law (Figure 3). Locations where effects of physical laws realise are called wirk elements (also function carriers, effective elements). There are four types of wirk elements: point, line, surface and volume. Connections among wirk elements which are located on the same part are made with the use of connecting structure. Basic schemata thus consist of physical quantities, wirk elements and connecting structure. Every physical law is represented by its own basic schema. Based on the physical law the complementary basic schema consist of one causal and of one effective physical quantity, of zero or several conditional physical quantities, of one or several wirk elements and of connecting structure if needed [Rihtaršič et al. 2008].

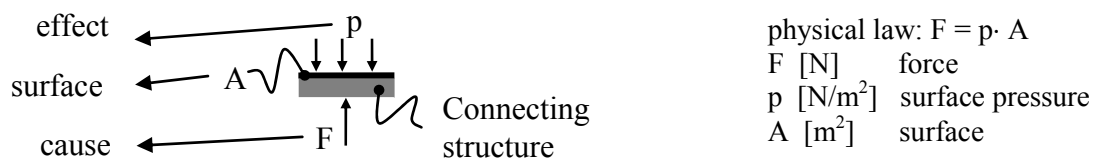

Figure 3. Basic schema that is complementary to static pressure physical law

Basic schema enables connection among physical quantities and among wirk elements. Chains of basic schemata are generated simultaneously with generation of chains of physical laws. Connections are possible within one linear chain of basic schemata or among basic schemata from different chains of basic schemata. This way the construction of “complicated” TS is possible. Connections and relations among wirk elements of so generated TS represent the first step towards the structure of TS. Generation of conceptual TS starts with selection on physical laws which effect will contribute to fulfilment of the function for which the TS is going to be designed. In the following step the list of chains of physical laws are automatically generated. The chains of basic schemata are generated simultaneously with the chain of physical laws. In the process of structural design, the wirk elements are shaped but the relations between physical quantities and wirk elements must be maintained.

5. Implementation of the method into the computer tool

The computer tool based on the presented model for generation and synthesis of conceptual TS is called Sophy, an acronym for **S**ynthesis of **p**hysical laws. The application was developed in C++ language with implementation of QT (trolltech) libraries. A graphical user interface enables multi-document display which makes transition between abstract and concrete model of the conceptual TS practical.

The computer tool consists of three modules: (i) a module for generation of basic schema (basic schema module), (ii) an idea generation module (chaining wizard) and (iii) a module for structural synthesis (structural wizard) (Figure 4).

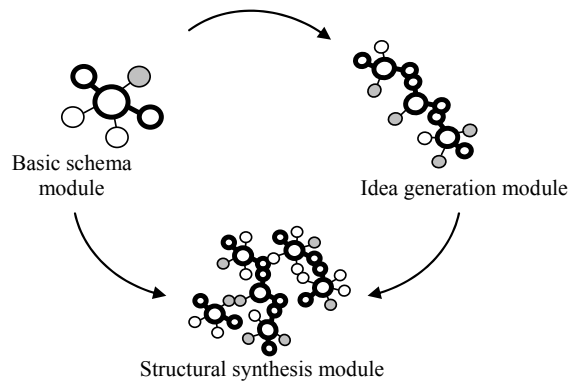

Figure 4. The Sophy computer tool for support in the conceptual design phase consists of three modules: a) a Basic schema module, b) an Idea generation module and c) a Structural synthesis module

5.1 The Basic schema module

The Basic schema module is used for generation of libraries of basic schemata. An important feature of the Basic schema module is that it allows customization and generation of new basic schemata, which can be added to the existing set of basic schemata. This enables the user to adapt the computer tool to different technical domains and moreover to his/hers personal knowledge and perception of the physical laws. Basic schemata are generated by assembly of geometric elements and physical quantities (Figure 5).

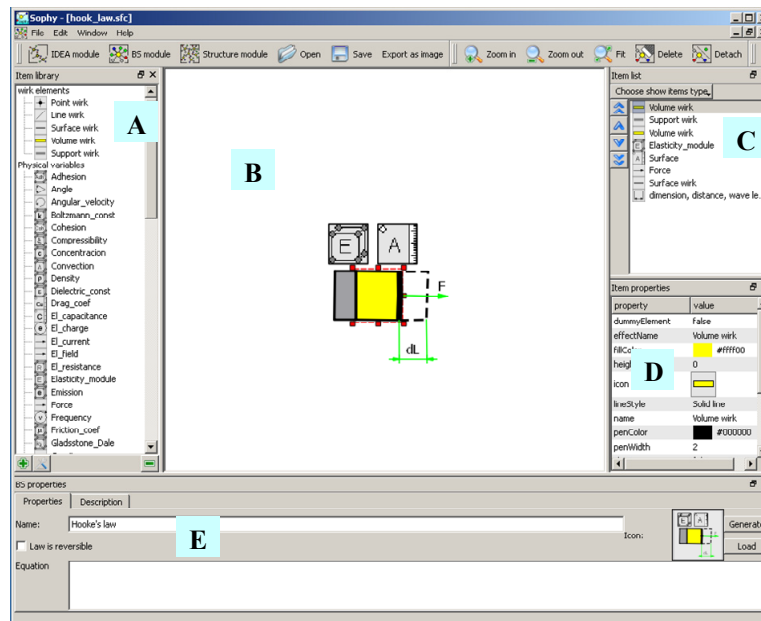

Figure 5. Basic schema module; A – item library, B – basic schema design space, C – item list, D – item properties and E – basic schema properties

The set of physical quantities and graphical elements is shown in the item library (Figure 5 - section A). They are dragged from the item library into the basic schema design space, where they are used to build a basic schema (Figure 5 – section B). Used quantities and elements appear in the item list (Figure 5 – section C). The properties of the active item are displayed in the item properties menu (Figure 5 – section D). The same physical quantities and graphical elements are used for basic schema generation, as well as for structural synthesis of conceptual TS. Properties of the physical law presented by basic schema, its description and basic schema icon are generated and stored in the basic schema properties window (Figure 5 – section E).

5.2 The idea generation module

There is often a range of potential solutions for fulfilment of a desired function. In presented approach, the solution space is generated automatically by chaining physical laws. Automatic generation of solution space shortens the time spent for its construction and also generates ideas that are physically feasible but not always found in existing design catalogues.

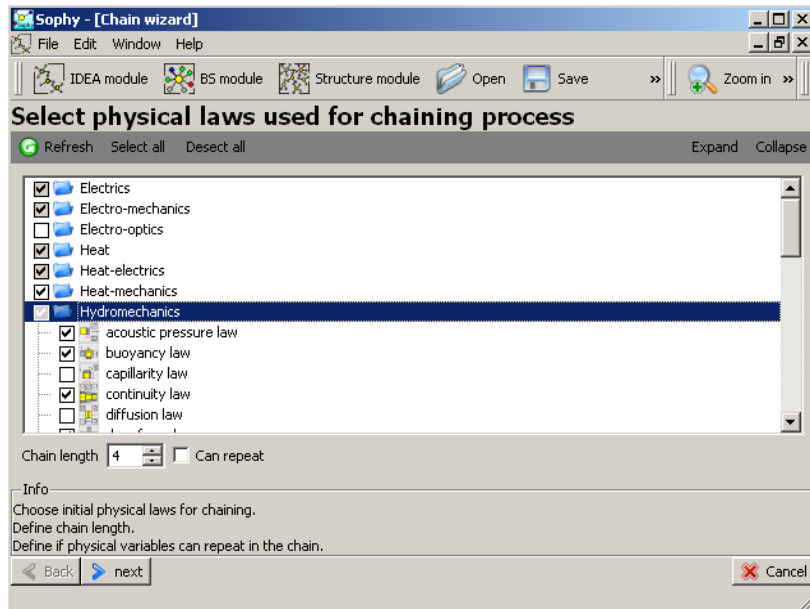

Figure 6. Selection of physical domains and physical laws which are used in the chaining process

In the majority of cases, a system of physical laws is needed to describe complete functionality of TS. By generating a chain of physical laws we solve mainly one function at the time. First we focus on fulfilment of the TSs main function which represents the functional and structural backbone of the intended TS. The procedure starts with selection of the physical domains and with selection of physical laws within chosen physical domains. Selected physical laws will be used for chaining process (Figure 6).

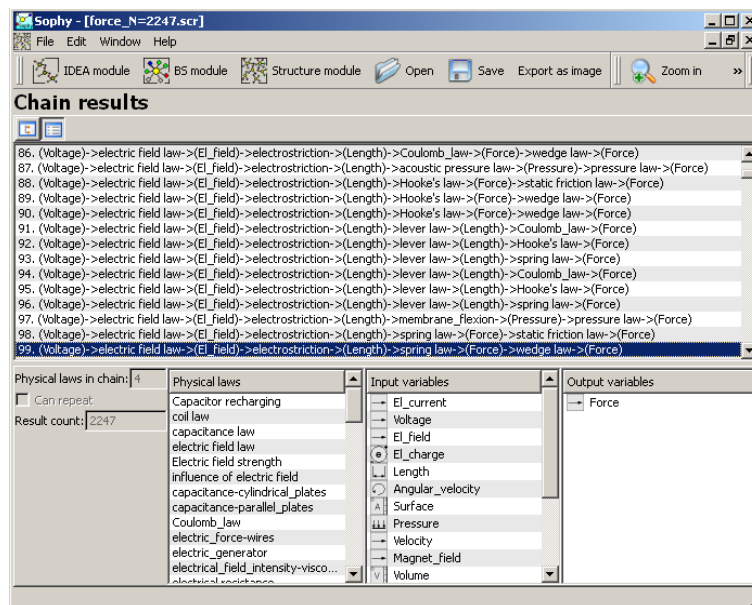

Figure 7. Results of the chaining process

Program suggests only those input and output physical quantities which are found in the selected physical laws. The user further controls the results of the chaining algorithm with the selection of input and output variables. There are three possible input/output patterns: (i) specified input/specified output, (ii) specified input/unspecified output, (iii) unspecified input/specified output. Although it is possible to select several input variables which are initial chaining variables and several output variables which exit from the chaining process, the chain presents a single input and single output system (SISO). The result of the chaining process is a list of possible chains of physical laws that connect the specified input and output variables (Figure 7). Multiple inputs and multiple outputs are possible by combining chains in the structural synthesis module (Figure 8). Additionally, information about the number of generated chains, the physical laws used, and the input and output variables are provided. With double click on a chain from chain result list (Figure 7), we automatically activate the structural synthesis module (Figure 8).

5.3 Structural synthesis module

To enable structural synthesis of the complete TS several chains of basic schemata from different chaining procedures, as well as basic schema that represent individual physical law, can be imported into the structural design space (Figure 8 - A).

Initially, the chain of basic schemata is connected via variables that represent causes and effects. By activating the individual basic schema from the chain of basic schemata, it is possible to visualize its physical quantities and WE which are further used for develop of a map of connections between the physical laws and the structure of the conceptual TS. The map of connections shows which physical laws share which physical quantities and geometric elements. It captures the information about the functioning of the TS which thus no longer presents a black box.

At this stage, a design engineer can proceed in two directions for final embodiment of the conceptual TS which is designed according to the previously developed map model in the structural design space. One possibility is to drag the icon that represent basic schema from the structural design space into the TS design space. By dragging the basic schema icon into the TS design space window, the constituent geometric elements and physical quantities of the dragged basic schema appear inside design space window. Alternative possibility is to drag physical quantities and wirk elements directly from the item library. The structural embodiment of the selected chain of physical laws from Figure 7 presents a micro brush (Figure 8 - B).

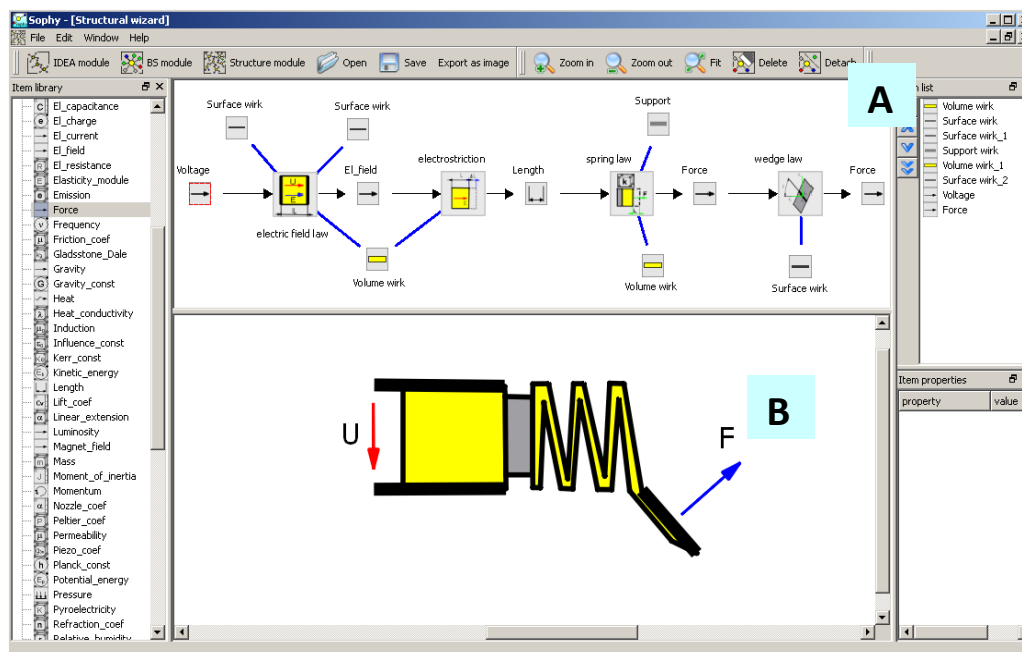

Figure 8. The structural synthesis module

An example of structural connection of a system of chains of physical laws is shown on Figure 9. Conceptual TS from Figure 9 presents a physical solution and its structural embodiment for separation of water droplets from working fluid (e.g. air). Needed effects for water droplet separation were set on the basis of analysis of existing working principles. Water droplet separation can be done by centrifugal effect, cyclone effect, adsorption, absorption, electric precipitation, gravity law, etc.... Automated search through basis of physical laws was conducted to obtain all physical laws with the same effect. After selection of effects was made the two individual physical laws and a chain of two physical laws were dragged into structural synthesis module. The solution from Figure 9 is based on continuity effect, electric field effect and electro osmosis effect.

In the process of water separation the droplets are polarized which makes them to move toward the oppositely charged surface of the porous tube surface. The electro osmosis effect makes the water droplets to move towards the centre of the tube and the dry air continues to flow along the outside surface of the tube.

Structural synthesis started by identification of wirk elements. Volume flow is common to all three effects however only the part of flow (water droplets) is used in the electro osmosis process. Physical laws prescribe material properties and the conditional physical quantities that are needed for realization of individual effect. Wirk elements (wet air flow, water droplets, electrically charged surface) as well as physical quantities (voltage, electric field) connect individual physical laws and chain of physical laws into a system of physical laws.

The final shape of so generated conceptual TS is left to designer's creativity (e.g. charging the water droplets over the surfaces of compressor blades); however the relations between wirk elements and their material properties have to be maintained. To support this phase of concept development wirk elements need to allow their modification, translation, rotation, etc. [Rihtaršič et al. 2009]. The map of wirk elements and physical quantities supports the growth of design knowledge. Designer can visualize how structural changes influence the functionality of TS.

The above described combination of physical effects was not known to authors before and it was build according to basic schema proposal.

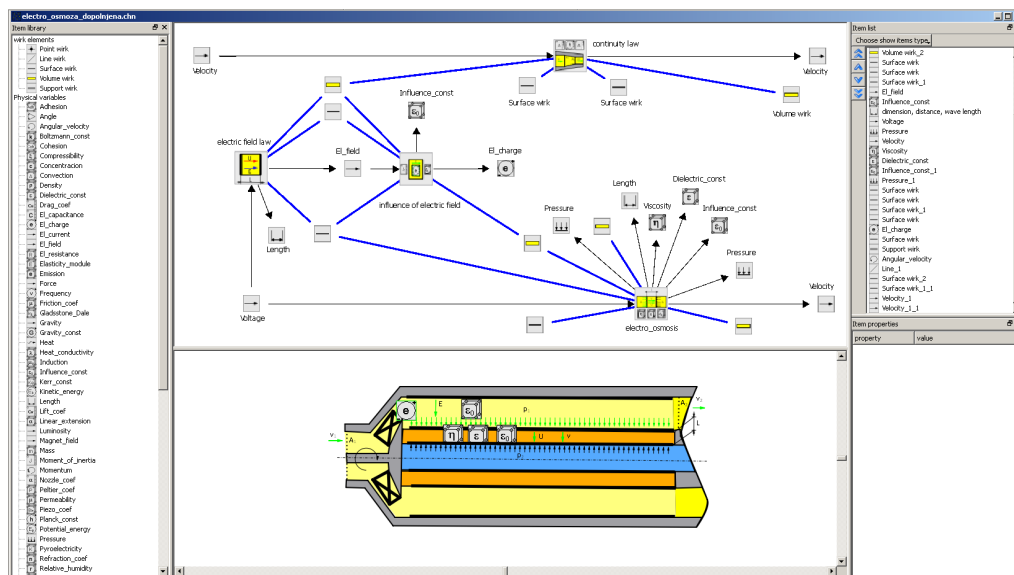

Figure 9. The structural synthesis module

6. Conclusion

The presented method and a computer tool to support of the conceptual design phase enable idea generation and its development into structural conceptual TS. The knowledge base used for this semi-automated generation of conceptual TS consists of a set of 139 physical laws. Physical laws enable a mapping between the functional domain and the structural domain. A decomposition problem-solving strategy was applied for synthesis of conceptual TS. This technique enables enhancement of basic

functions by proposing effects from different domains of physics for fulfilment of the desired function. Solutions generated by chaining of physical laws simultaneously generate a chain of complementary basic schemata. A basic schema is a structural representation of a physical law. Although a basic schema consists of relatively small number of physical quantities and geometric elements (WE), it enables its structural customization according to user perception of the particular physical law. Synthesis of the conceptual TS is performed by the coupling of the basic schemata. Complete conceptual TS are synthesized by activating all the chains of physical laws which are needed for complete functionality of the conceptual TS. Basic schemata enable connections between individual chains of physical laws. The connections are made over the physical quantities and over the work elements.

The main argument for automated computational methods and tools in the conceptual design phase is to reduce the time and resources spent searching and developing conceptual solutions for desired functions. The abstractness and uncertainty of the conceptual phase present a big challenge for computerized algorithms. The consequences of these two characteristics of conceptual design phase are large numbers of solutions, many of which are unsuitable. The problem of "big numbers" can be managed by using control algorithms, but the final qualitative evaluation still depends in majority of cases on the reasoning of the design engineer. Important characteristics that need to be addressed for computerized concept generation and embodiment are lack of completeness of concepts, flexibility of structural elements and their applicability in diverse physical environments. Finally, so generated design knowledge about the intended TS and its storage are also important and speak in favour of computational tools in conceptual design phase.

References

- Mortensen N.,H., "Design modeling in a designer's workbench – contribution to a design language" PhD dissertation, Lyngby: Technical University of Denmark; 1999.
- Bender B., "Erfolgreiche individuelle vorgehensstrategien in frühenphasen der productentwicklung" PhD dissertation, Düsseldorf: VDI Verlag GmbH; 2004.
- Ullman D.,G., "Towards the ideal mechanical engineering design support systems" *Research in Engineering Design* 2002; 13(2), pp.55–64.
- Koller R., Kastrop N., "Prinziplösungen zur konstruktion technischer produkte", Berlin-Heidelberg: Springer-Verlag; 1994.
- Chakrabarti A., "A new approach to structure sharing" *Journal of Computing and Information Science in Engineering*, (4), 2004, pp.11-19
- Žavbi R., Duhovnik J., "Conceptual design of technical systems using functions and physical laws", *Artificial Intelligence for Engineering Design, Analysis and Manufacturing* 2000; 14, pp. 69–83
- Rihtaršič, J., Žavbi, R., Duhovnik, J., "Application of Wirk Elements for Elementary Embodiments of Technical Systems", *ICED 07 Bocquet, J.C. (ed), Paris, 2007, file no.262*
- Rihtaršič J., Žavbi R., Duhovnik J., "Physical nature of technical systems" *Proceedings of DESIGN 08*, D. Marjanovič, M. Štorga, N. Pavković, N. Bojčetić, (eds), Vol.1, pp. 53–60, file no.167, 2008.
- Rihtaršič J., Žavbi R., Duhovnik J., "Properties of elementary structural elements for synthesis of conceptual technical systems", *Proceedings of Icord 09, A. Chakrabarti (ed), Indian Institute of Science, Bangalore, 2009, pp. 11-17.*

Dr. Janez Rihtaršič
University of Ljubljana, Faculty of Mechanical Engineering
Aškerčeva 6, 1000 Ljubljana, Slovenija
Telephone: + 386 1 4771 775
Email: janez.rihtarsic@lecad.uni-lj.si
URL: <http://www.lecad.uni-lj.si>